

For more information contact Synergy Positioning Systems or
visit the Synergy Positioning Systems website at www.synergypositioning.co.nz
All branches: Phone 0800 867 266 Email: info@synergypositioning.co.nz

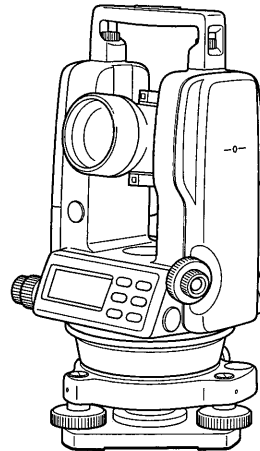

**INSTRUCTION MANUAL
DIGITAL THEODOLITE**

DT-200/200L SERIES



30321 90052



CE **EMC NOTICE**
In industrial locations or in proximity to industrial power installations, this instrument might be affected by electromagnetic noise. Under such conditions, please test the instrument performance before use.

FOREWORD

Thank you for purchasing the TOPCON Digital Theodolite. For the best performance of the instruments, please carefully read these instructions and keep them in a convenient location for future reference.

General Handling Precautions

Before starting work or operation, be sure to check that the instrument is functioning correctly with normal performance.

Do not submerge the instrument into water.

The instrument can not be submerged underwater.

The instrument is designed based on the International Standard IP66, therefore it is protected from the normal rainfall.

Setting the instrument on a tripod

When mounting the instrument on a tripod, use a wooden tripod when possible. The vibrations that may occur when using a metallic tripod can effect the measuring precision.

Installing the tribrach

If the tribrach is installed incorrectly, the measuring precision could be effected. Occasionally check the adjusting screws on the tribrach. Make sure the base fixing lever is locked and the base fixing screws are tightened.

Guarding the instrument against shocks

When transporting the instrument, provide some protection to minimize risk of shocks. Heavy shocks may cause the measurement to be faulty.

Carrying the instrument

Always carry the instrument by its handgrip.

Exposing the instrument to extreme heat.

Do not leave the instrument in extreme heat for longer than necessary. It could adversely affect its performance.

Sudden changes of temperature

Any sudden change of temperature to the instrument or prism may result in a reduction of measuring distance range, i.e when taking the instrument out from a heated vehicle. Let instrument acclimate itself to ambient temperature. When a high degree of precision is required for measurement, provide shade against direct sunlight for the instrument and tripod.

Battery level check

Confirm battery level remaining before operating.

Store with the batteries removed, when operation is halted for more than a month. Leaving the batteries attached for extended period of time can result in battery leakage, which may lead to malfunctioning.

Notice on Transceiver

When using high output transceiver etc., make sure it does not come near the instrument.



Opening the carrying case

When opening the carrying case and taking out the instrument, place the case horizontally, then open the case.

Display for Safe Use

In order to encourage the safe use of products and prevent any danger to the operator and others or damage to properties, important warnings are put on the products and inserted in the instruction manuals.

We suggest that everyone understand the meaning of the following displays and icons before reading the "Safety Cautions" and text

Display	Meaning
 WARNING	Ignoring or disregard of this display may lead to the danger of death or serious injury.
 CAUTION	Ignoring or disregard of this display may lead to personal injury or physical damage.

- Injury refers to hurt, burn, electric shock, etc.
- Physical damage refers to extensive damage to buildings or equipment and furniture.

Safety Cautions

 WARNING
<p>•There is a risk of fire, electric shock or physical harm if you attempt to disassemble or repair the instrument yourself. This is only to be carried out by TOPCON or an authorized dealer, only!</p>
<p>•Laser beams can be dangerous, and can cause eye injury's if used incorrectly. <u>Never attempt to repair the instrument yourself.</u></p>
<p>•Cause eye injury or blindness. Do not stare into beam.</p>
<p>•Cause eye injury or blindness. Do not look at the sun through a telescope.</p>
<p>•High temperature may cause fire. Do not connect the battery to an instrument while it is charging.</p>
<p>•Risk of fire or electric shock. Do not use a wet battery or charger.</p>
<p>•May ignite explosively. Never use an instrument near flammable gas, liquid matter, and do not use in a coal mine.</p>

<p>•Battery can cause explosion or injury. Do not dispose in fire or heat.</p>
<p>•Risk of fire or electric shock. Do not use any power voltage except the one given on manufacturers instructions.</p>
<p>•Battery can cause outbreak of fire. Do not block up the vent of the battery.</p>
<p>•The short circuit of a battery can cause a fire. Do not short circuit battery when storing it.</p>

 **CAUTION**

<p>Use of controls or adjustment or performance of procedures other than those specified herein may result in hazardous radiation exposure.</p>
<p>Do not connect or disconnect equipment with wet hands, you are at risk of electric shocks if you do!</p>
<p>Risk of injury by overturn the carrying case. Do not stand or sit on the carrying cases.</p>
<p>Please note that the tips of tripod can be hazardous, be aware of this when setting up or carrying the tripod.</p>
<p>Risk of injury by falling down the instrument or case. Do not use a carrying case with a damaged which belts, grips or latches.</p>
<p>Do not allow skin or clothing to come into contact with acid from the batteries, if this does occur then wash off with copious amounts of water and seek medical advice.</p>
<p>A plumb bob can cause an injury to a person if used incorrectly.</p>
<p>It could be dangerous if the instrument falls over, please ensure you attach a handle to the instrument securely.</p>
<p>Ensure that you mount the Tribach correctly, failing to do so may result in injury if the tribrach were to fall over.</p>
<p>It could be dangerous if the instrument falls over, please check that you fix the instrument to the tripod correctly.</p>
<p>Risk of injury by falling down a tripod and an instrument. Always check that the screws of tripod are tightened.</p>

Laser Safety

DT-205L/207L/209L uses the visible laser beam. DT-205L/207L/209L products are manufactured and sold in accordance with "Radiation Safety of Laser Products, Equipment Classification, Requirements and User's Guide" (IEC Publication 60825-1) or "Performance Standards for Light-Emitting Products" (FDA/BRH 21 CFR 1040) provided on the safety standards for laser beam.

As per the said standards, DT-205L/207L/209L classified as "Class 2 (CLASS II) Laser Products".

The laser beam belongs not very dangerous type but we request you to keep and understand "Safety standard for users" as mentioned in the manual instruction.

In case of any failure, do not disassemble the instrument. Contact TOPCON or your TOPCON dealer.

Labels

Find the labels which describes the caution and safety about the laser beam as follows in DT-205L/207L/209L. We request you to replace it one anytime the caution labels are damaged or lost and paste a new one at the same place. You can get the labels from Topcon or your dealer.

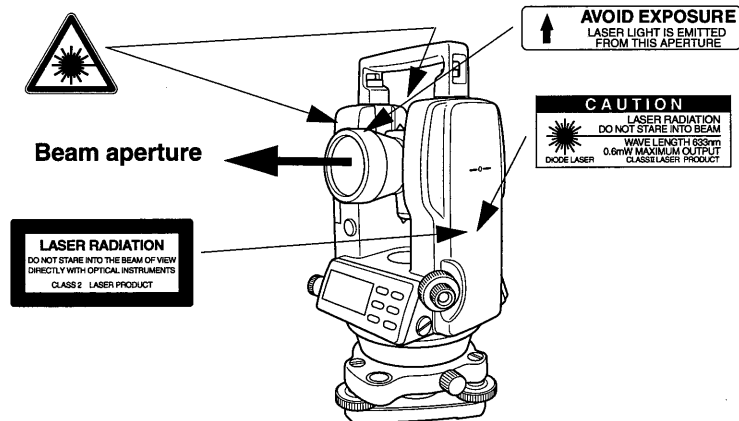

Depending on the country where the instrument is sold, either of these labels may be found on the instrument.

User

- 1) This product is for professional use only!
The user is required to be a qualified surveyor or have a good knowledge of surveying, in order to understand the user and safety instructions, before operating, inspecting or adjusting.
- 2) Wear the required protectors (safety shoes, helmet, etc.) when operating.

Exceptions from Responsibility







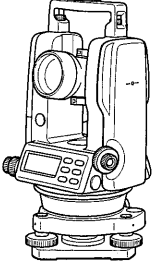

- 1) The user of this product is expected to follow all operating instructions and make periodic checks of the product's performance.
- 2) The manufacturer, or its representatives, assumes no responsibility for results of a faulty or intentional usage or misuse including any direct, indirect, consequential damage, and loss of profits.
- 3) The manufacturer, or its representatives, assumes no responsibility for consequential damage, and loss of profits by any disaster, (an earthquake, storms, floods etc.).
A fire, accident, or an act of a third party and/or a usage any other usual conditions.
- 4) The manufacturer, or its representatives, assumes no responsibility for any damage, and loss of profits due to a change of data, loss of data, an interruption of business etc., caused by using the product or an unusable product.
- 5) The manufacturer, or its representatives, assumes no responsibility for any damage, and loss of profits caused by usage except for explained in the user manual.
- 6) The manufacturer, or its representatives, assumes no responsibility for damage caused by wrong movement, or action due to connecting with other products.

Contents

	FOREWORD	1
	General Handling Precautions	2
	Display for Safe Use	4
	Safety Cautions	4
	Laser Safety	6
	User	7
	Exceptions from Responsibility	7
	Contents	8
	Standard Set Composition	9
1	NOMENCLATURE AND FUNCTIONS	10
	1.1 Nomenclature	10
	1.2 Display	14
	1.3 Operating keys	14
2	PREPARATION FOR MEASUREMENT	16
	2.1 Setting Instrument Up for Measurement	16
	2.2 Power Switch Key ON	18
	2.3 Battery Level Indicator	19
	2.4 Vertical Angle Tilt Correction	19
	2.5 Serial Signal RS-232C Connector	19
3	MEASUREMENT	20
	3.1 Measuring Horizontal Angle Right and Vertical Angle	20
	3.2 Switching Horizontal Angle Right / Left	21
	3.3 Measuring from the Required Horizontal Angle	22
	3.4 Vertical Angle % display	22
	3.5 Repetition Angle Measurement	23
	3.6 Stadia Surveying	25
4	HOW TO OPERATE THE LASER	26
5	THE OTHER FUNCTIONS	27
	5.1 Buzzer Sounding for Horizontal Angle 90° Increments	27
	5.2 Compasses (vertical angle)	27
	5.3 Auto Cut Off	27
	5.4 Setting Minimum Angle Reading	27
	5.5 Detach / Attach of Tribrach	28
6	SELECTING MODE	29
	6.1 Items of the Selecting Mode	29
	6.2 How to Set the Selecting Modes	31
7	HANDLING POWER SOURCE	34
	7.1 For removing	34
	7.2 Replace the battery (DB-35)	34
	7.3 For installing	34
8	CHECK AND ADJUSTMENT	35
	8.1 Checking /Adjusting the Plate Level	36
	8.2 Checking and Adjusting the Circular Level	37
	8.3 Adjustment of the Vertical Cross-hair	38
	8.4 Collimation of the Instrument	40
	8.5 Checking and Adjusting the Optical Plummet Telescope	42
	8.6 Adjustment of Vertical Angle 0 Datum	43
	8.7 Adjustment of Laser Beam	44
9	STORAGE PRECAUTIONS	45
10	OPTIONAL ACCESSORIES	46
11	ERROR DISPLAY	47
12	SPECIFICATIONS	48

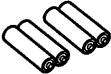
Standard Set Composition

The numerical value in parentheses shows the quantity.

<p>Instrument (1) (with lens cap)</p> 	<p>Carrying case(1)</p> 
<p>Plumb bob set (1)</p> 	<p>Tool kit (1) Cleaning brush, Screw driver, Rod pins, Plumb bob hook <small>(Hexagonal wrench : Only for DT-205/207/209/209P)</small></p> 
<p>AA batteries (4)</p> 	<p>Plastic rain cover (1)</p> 
<p>Silicon cloth (1)</p> 	<p>Instruction manual (1)</p> 

- Make sure that all of the above items are with the instrument when purchased.
- Guarantee card, Laser use card, Caution sticker are supplied for certain markets.

1 NOMENCLATURE AND FUNCTIONS

1.1 Nomenclature

DT-205/207/209/209P

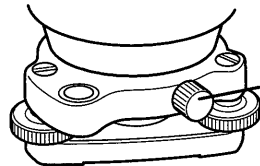
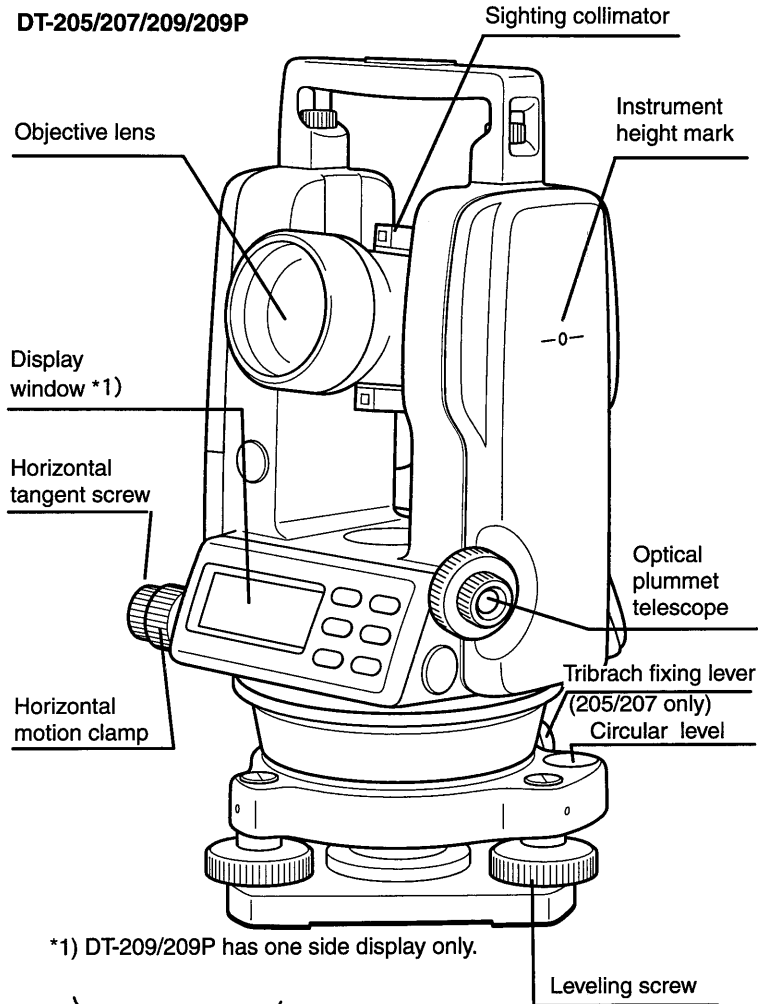

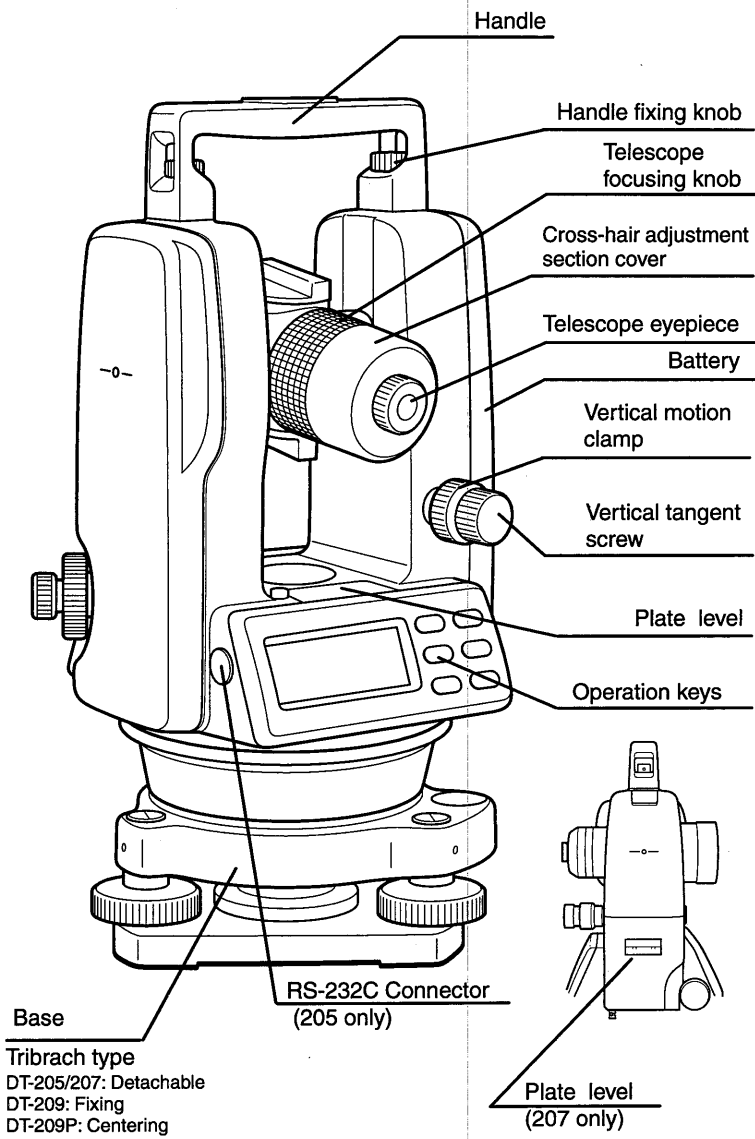

DT-205L/207L/209L

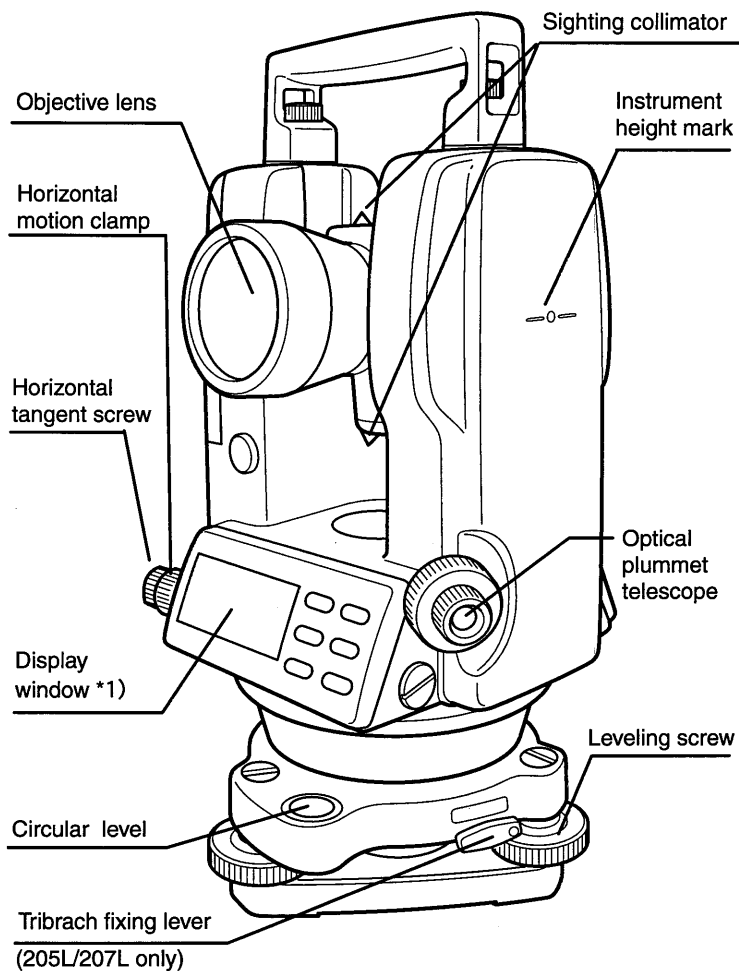

*1) DT-209L has one side display only.

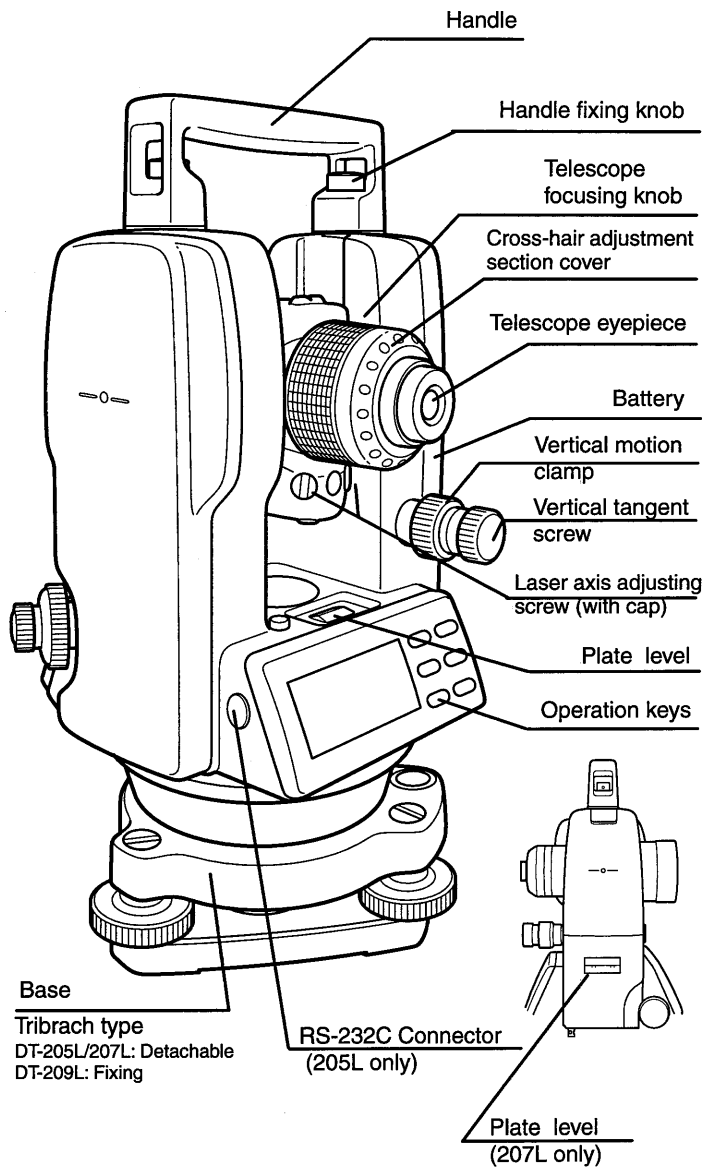

Adjustment mode and Selecting mode

Mode	Key
Adjustment mode of vertical angle 0 datum	Turn the power ON while pressing the [0 SET] key.
Selecting mode 1	Turn the power ON while pressing the [R/L] key.
Selecting mode 2	Turn the power ON while pressing the [V/%] key.

2 PREPARATION FOR MEASUREMENT

2.1 Setting Instrument Up for Measurement

Setting up the Tripod

First, extend the extension legs to suitable lengths and tighten the screws on their midsections.

Attaching the Instrument on the Tripod Head

Place the instrument carefully on the tripod head and slide the instrument by loosening the tripod screw. If the plumb bob is positioned right over the center of the point, slightly tighten the tripod screw.

Roughly Leveling the Instrument by Using the Circular Level

- 1) Turn the leveling screws A and B to move the bubble in the circular level. The bubble is now located on a line perpendicular to a line running through the centers of the two leveling screws being adjusted.
- 2) Turn the leveling screw C to bring the bubble to the center of the circular level.

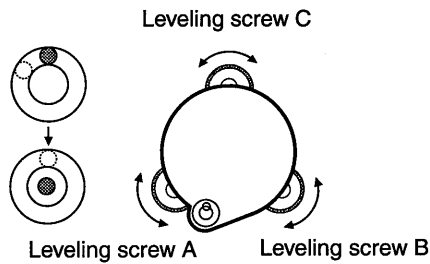

Centering by Using the Plate Level

- 1) Rotate the instrument horizontally by using the Horizontal motion/clamp screw and place the plate level parallel with the line connecting leveling screws A and B, and then bring the bubble to the center of the plate level by turning leveling screws A and B.

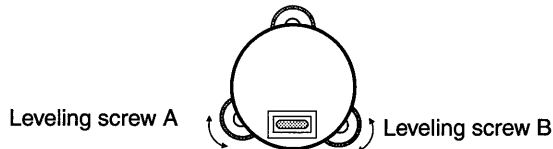

- 2) Rotate the instrument 90° (100g) around its vertical axis and turn the remaining leveling screw or C to center the bubble once more.

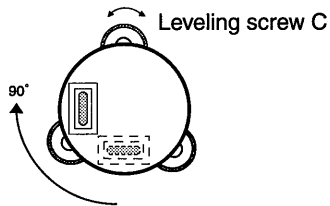

- 3) Repeat the procedures 1 and 2 for each 90° (100g) rotation of the instrument and check whether the bubble is correctly centered for all four points.

Centering by Using the Optical Plummet Telescope

Adjust the eyepiece of the optical plummet telescope to your eyesight. Slide the instrument by loosening the tripod screw, place the point on the center mark, and then tighten the tripod screw. Sliding the instrument carefully not to rotate that allows you to get the least dislocation of the bubble

Completely Leveling the Instrument

Leveling the instrument precisely in a similar way to 4. Rotate the instrument and check to see that the bubble is in the center of the plate level regardless of telescope direction, then tighten the tripod screw hard.

2.2 Power Switch Key ON

- 1 Confirm the instrument is leveled.
- 2 Turn the power switch ON.
Every segment turns on for about 1 second.

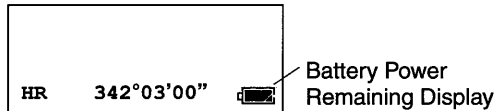
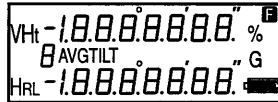

- 3 Press the [V/%] key. The vertical angle is displayed.

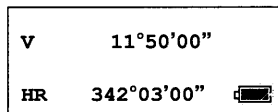

- Confirm the battery power remaining on the display. Replace with charged battery or charge when battery level is low. Refer to Section 2.3 "Battery Level Indicator".

2.3 Battery Level Indicator

The battery power indicator shows the level of battery strength.

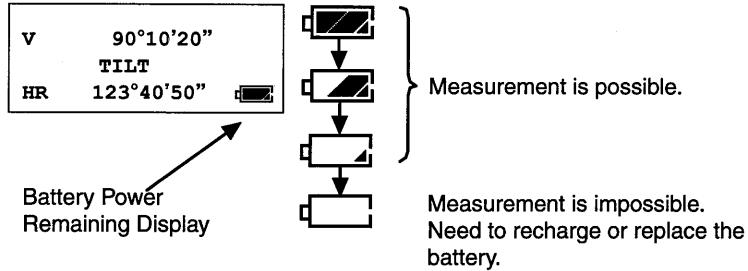

- 1) The battery operating time will vary depending on the environmental conditions, such as ambient temperature etc. It is recommended for safety to prepare spare batteries.
- 2) For general usage of battery, see chapter 7 "HANDLING POWER SOURCE"

2.4 Vertical Angle Tilt Correction

(DT-205/205L only)

When the tilt sensor is activated, automatic correction of vertical angle for mislevelment is displayed. To ensure a precise angle measurement, tilt sensors must be turned on. If the "b" display appears the instrument is out of automatic compensation range and must be leveled manually.

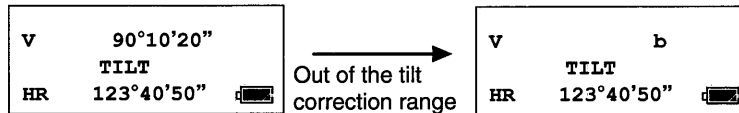

In case the instrument is used in an unstable situation, constant indexing of vertical angle may be impossible. In this case, the function of tilt correction can be stopped.

To stop the function of tilt correction, refer to Chapter 6 "SELECTING MODE".

2.5 Serial Signal RS-232C Connector

(DT-205/205L only)

Serial signal connector is used for connecting the DT-205/205L with a computer, which enables the computer to receive measurement data from the DT-205/205L.

3 MEASUREMENT

3.1 Measuring Horizontal Angle Right and Vertical Angle

1 Collimate the first target "A".

V	90°10'20"
HR	120°30'40"

2 Press the [0 SET] key twice to set the horizontal angle of target "A" at 0° 00' 00".

V	90°10'20"
HR	0°00'00"

- One time pressing [0 SET] function is available. Refer to "6 SELECTING MODE".

3 Collimate the second target "B".
The required H/V angle to target B will be displayed.

V	92°10'20"
HR	160°40'20"

3.2 Switching Horizontal Angle Right / Left

1 Collimate the first target "A".

V	90° 10' 20"
HR	120° 30' 40"

2 Press the [R/L] key.

The mode Horizontal angle right (HR) switches to Horizontal angle left (HL)

V	90° 10' 20"
H L	239° 29' 20"

- Every time pressing the [R/L] key, HR/HL mode switches.

3 Measure as HR mode.

Reference : How to Collimate

- 1 Point the telescope toward the light. Turn the diopter ring and adjust the diopter so that the cross hairs are clearly observed. (Turn the diopter ring toward you first and then backward to focus.)
- 2 Aim the target at the peak of the triangle mark of the sighting collimator. Allow a certain space between the sighting collimator and yourself for collimating.
- 3 Focus the target with the focusing knob.

*If parallax is created between the cross hairs and the target when viewing vertically or horizontally while looking into the telescope, focusing is incorrect or diopter adjustment is poor.

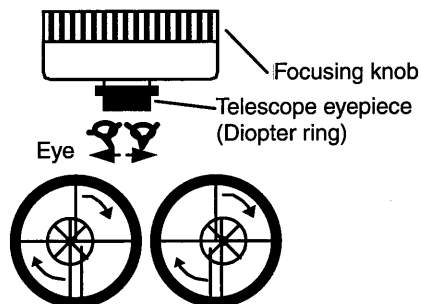

This adversely affects precision in measurement or survey. Eliminate the parallax by carefully focusing and using diopter adjustment.

3.3 Measuring from the Required Horizontal Angle

- 1 Display the required horizontal angle using the horizontal motion clamp and horizontal tangent screw.

V	90° 10' 20"
HR	130° 40' 20"

- 2 Press the [HOLD] key.

The display of horizontal angle blinks and the horizontal angle will be held.

V	90° 10' 20"
HR	130° 40' 20"

blinks

- To return to the angle status before the data is held, press any key except the [HOLD] key.
- 3 Collimate the target to set.
 - 4 Press the [HOLD] key. The angle measurement will start from the held angle.

V	90° 10' 20"
HR	130° 40' 20"

3.4 Vertical Angle % display

V	66° 23' 10"
HR	120° 30' 40"

- 1 Press the [V/%] key.

V	43.719%
HR	120° 30' 40"

- Every time pressing the [V/%] key, the mode switches. When the measurement is carried out over than 45° from the horizontal, the display shows [-----].

3.5 Repetition Angle Measurement

1 Press the [FUNC] key.

V	90°10'20" ^F
HR	120°30'40"

2 Press the [REP] key.

Ht	0°00'00"
H	0

3 Collimate the target "A", and press the [0SET] key twice.

Ht	0°00'00"
H	0

4 Collimate the target "B", and press the [HOLD] key.

Ht	45°10'00"
H	^{1AVG} 45°10'00"

5 Recollimate the target "A" and press the [R/L] key.

6 Recollimate the target "B", and press the [HOLD] key.

Ht	90°20'00"
H	^{2AVG} 45°10'00"

The number of measurements Average of angle

2 measurements

- 7** Repeat the procedure **5** and **6** to measure the desired number of repetition.

Ht	180°40'00"
^{4AVG}	
H	45°10'00"

Example: 4 measurements

- 8** To finish the repetition measurement, press the [FUNC] key and press the [HOLD] key.

- Horizontal angle can be accumulated up to (2000°00'00" – minimum reading) (horizontal angle right).
In case of 5 second reading, horizontal angle can be accumulated up to +1999°59'55".
- When the discrepancy value of each measuring is more than $\pm 30''$, the error code "E04" is displayed. Press the [0SET] key, and measure from the beginning.
- Maximum 19 measurements are available.
The 10th or more repetition measurements, the figure of 10th digit will be omitted.

3.6 Stadia Surveying

This instrument can be used for stadia surveying. Measurement by stadia is a convenient method for measuring distances with the stadia hairs of the instrument, in combination with a graduated rod, such as a leveling rod or stadia rod, which is preferable for long distances. The distance from the center of the instrument to the rod is found by sighting through the instrument on the rod and multiplying the stadia interval by 100. The stadia interval is the distance between the top stadia hair reading and the bottom stadia hair reading.

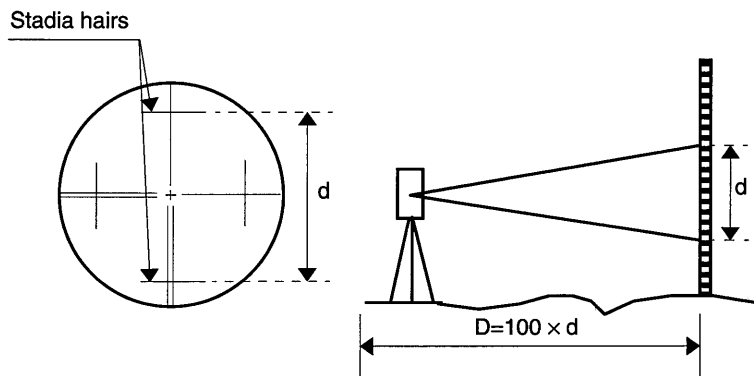

- 1 Set the rod on the point to be surveyed.
- 2 Sight through the telescope of the leveled instrument and determine the distance or interval, " d ", between the top stadia hair reading and bottom stadia hair reading of the rod.
- 3 The horizontal distance " D " from the center of the instrument to the rod is equal to 100 times the stadia interval, " d ".

$$D=100 \times d$$

4 HOW TO OPERATE THE LASER

(DT-205L/207L/209L only)

WARNING

Aiming the instrument into prism or highly reflective surface can result in serious damage to your eye because the optical axis and laser beam source is in coincidence.

Do not aim the instrument directly into prism or highly reflective surface.

Do not look at the laser beam directly.

•Laser beams can be dangerous, and can cause eye injury's if used incorrectly.

Never attempt to repair the instrument yourself.

- 1 Collimate a target.
- 2 Press the laser power switch.
The laser beam will emit and the green lamp will illuminate.

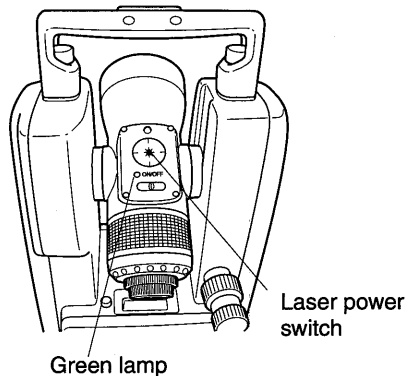

DT-205L/207L/209L are so designed as to provide the telescope and laser beam with simultaneous focussing to give the minimum spot.

5 THE OTHER FUNCTIONS

5.1 Buzzer Sounding for Horizontal Angle 90° Increments

When the horizontal angle falls in the range of less than $\pm 1^\circ$ of 0° , 90° , 180° or 270° , the buzzer sounds. Buzzer stops only when the horizontal angle is adjusted to $0^\circ 00' 00''$, $90^\circ 00' 00''$, $180^\circ 00' 00''$ or $270^\circ 00' 00''$.
To stop the buzzer sounding, refer to "6 SELECTING MODE".

5.2 Compasses (vertical angle)

Vertical angle scale is displayed as shown below.
To set this function, refer to "6 SELECTING MODE".

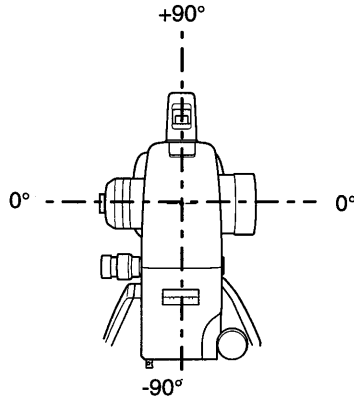

5.3 Auto Cut Off

If no key operation is given for more than 10 or 30 minutes, the power turns off automatically.

To set this function, refer to "6 SELECTING MODE".

5.4 Setting Minimum Angle Reading

Select minimum display unit for angle measurement. It is possible to select it as shown below.

To set this function, refer to "6 SELECTING MODE".

DT-205/205L	1" / 5" (0.5 mgon / 1 mgon)
DT-207/207L	5" / 10" (1 mgon / 2 mgon)
DT-209/209P/209L	10" / 20" (2 mgon / 5 mgon)

5.5 Detach / Attach of Tribrach

Only for detachable tribrach type

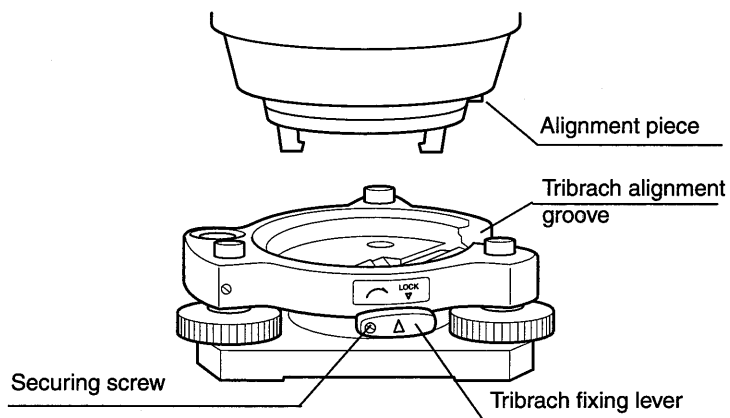

The instrument is easily detached or attached to the tribrach, with a tribrach locking lever loosened or tightened for this purpose.

● Detachment

- 1 Loosen the tribrach locking lever, by revolving it 180° or 200g in the counterclockwise direction (which will point the triangle mark upwards).
- 2 Grip the carrying handle firmly with one hand while holding the tribrach with the other. Then lift the instrument straight upwards and off.

● Attachment

- 1 Hold the instrument by the carrying handle, with one hand, and carefully lower it on top of the tribrach while, at the same time, coinciding the alignment piece with the tribrach alignment groove on the instrument and tribrach respectively.
- 2 When fully seated, revolve the tribrach locking lever 180° or 200g clockwise (which will point the triangle mark downwards again).

● Locking the Tribrach Locking Lever

The tribrach locking lever can be locked, to prevent it be accidentally removed, especially if the upper instrument section is not being detached very often. Simply tighten the securing screw on the locking lever with the accessory screwdriver, found in the case.

6 SELECTING MODE

The following modes are available

6.1 Items of the Selecting Mode

Selecting mode 1

To set the instrument the selecting mode 1, turn the power ON while pressing the [R/L] key.

Selecting mode 1
[R/L] key + Power on

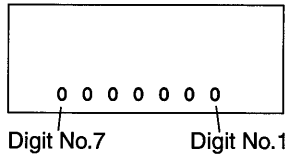

Selecting mode 1				
Digit No.	Items	Contents	Setting value = 0	Setting value = 1
1	Minimum angle unit	Select the minimum angle unit.	5" (DT-205/205L) 10" (DT-207/207L) 20" (DT-209/209P/ 209L)	1" 5" 10"
2	V angle Z0 / H0	Select the vertical angle reading from zenith or from horizontal.	Horizontal 0	Zenith 0
3	Auto cut off ON/OFF	Set the function of power off automatically when no key operation is continued 10 or 30 minutes.	ON	OFF
4	Auto cut off time 10 min. / 30 min.	Set the interval time of power off automatically.	10 min.	30 min.
5	Angle unit DEG/GON	Choose degree (DEG), gon (GON).	DEG	GON
6	90° buzzer ON/OFF	Specify whether the buzzer sounds or not for every horizontal 90°	ON	OFF
7	Angle unit MIL	Choose angle unit MIL.	DEG /GON	MIL

Selecting mode 2

To set the instrument the selecting mode 2, turn the power ON while pressing the [V/%] key.

Selecting mode 2
[V/%] key + Power on

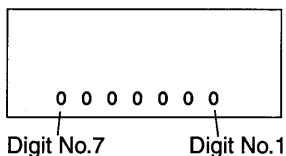

Selecting mode 2				
Digit No.	Items	Contents	Setting value = 0	Setting value = 1
1	[0 SET] key pressing once / twice	Choose once or twice for pressing the [0 SET] key.	Twice	Once
2	Compass ON/OFF	Set the function of compass (Vertical angle scale).	OFF	ON
3	RS-232 Output *1)	Set the function of sending the measured data.	OFF	ON
4	H Angle Memory	Horizontal angle set can be retained after the power is turned off.	OFF	ON
5	Tilt correction ON/OFF *1)	Set the function of the tilt correction.	OFF	ON
6	Unused			
7		---	---	---

- Do not change the setting value (0) of unused items.
- *1)DT-205/205L only

6.2 How to Set the Selecting Modes

● Selecting Mode 1

Sample setting: Auto cut off : OFF, 90° buzzer : OFF

- 1 Turn the power ON while pressing the [R/L] key.
The instrument will be in the selecting mode 1, and the digit No.1 will blink.

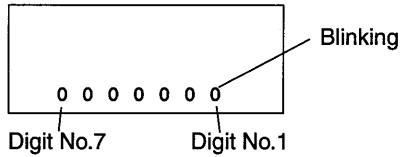

- 2 Let the digit No.3 to be set blink by pressing the [◀] key.

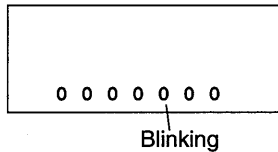

- Pressing the [▶] key, blinking digit moves to the right.

- 3 Press the [▲] key to set 1 for the digit.

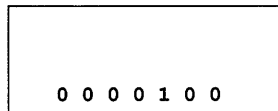

- Every time pressing the [▲] key, the blinking digit value 0/1 switches.

- 4 Let the digit No.6 (90° buzzer) to be set blink by pressing the [◀] key.

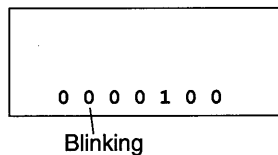

- 5 Press the [▲] key to set 1 for the digit.

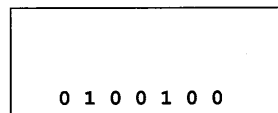

6 Press the [0 SET] key to set the setting.

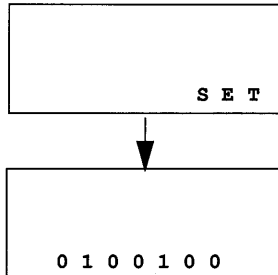

7 Turn the power off.

● **Selecting mode 2**

Sample setting: [0 SET] key pressing : Once, Tilt correction : OFF

1 Turn the power ON while pressing the [V/%] key.

The instrument will be in the selecting mode 2, and the digit No.1 (Oset key pressing) will blink.

0 0 1 0 0 0 0

Blinking

2 Press the [▲] key to set 1 for the digit.

0 0 1 0 0 0 1

• Every time pressing the [▲] key, the blinking digit value 0/1 switches.

3 Let the digit No.4 (Tilt correction) to be set blink by pressing the

[◀] key.

0 0 1 0 0 0 1

Blinking

• Pressing the [▶] key, blinking digit moves to the right.

4 Press the [▲]key to set 0 for the digit.

0 0 0 0 0 0 1

5 Press the [0 SET] key to set the setting.

S E T



0 0 0 0 0 0 1

6 Turn the power off.

7 HANDLING POWER SOURCE

7.1 For removing

- 1 Push the lock lever downward and pull out the battery.

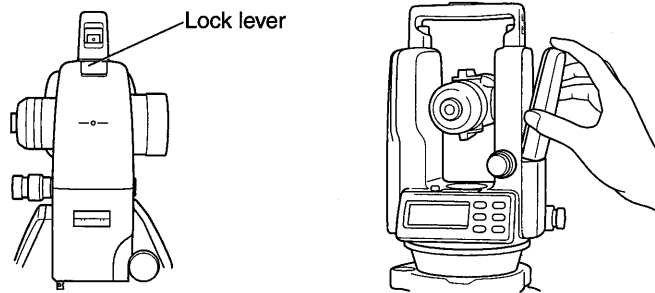

7.2 Replace the battery (DB-35)

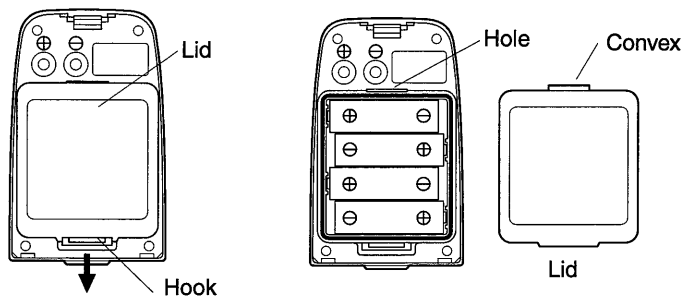

- 1 Push the hook downward and take the lid out.
- 2 Take out the old batteries and put new batteries as illustration shows in direction of plus and minus sides
- 3 Insert a convex in a upper hole. Click to close the lid by pressing it.



- Replace all four batteries to new ones at the same time.
- Do not mix the old batteries to the new ones.

7.3 For installing

Place the base of the battery into the main body, push the battery toward the instrument side till the battery clicks into position.

8 CHECK AND ADJUSTMENT

● Pointers on the Adjustment

- 1 Adjust the eyepiece of the telescope properly prior to any checking operation which involves sighting through the telescope. Remember to focus properly, with parallax completely eliminated.
- 2 Carry out the adjustments in the order of item numbers, as the adjustments are dependent one upon another. Adjustments carried out in the wrong sequence may even nullify previous adjustment.
- 3 Always conclude adjustments by tightening the adjustment screws securely (but do not tighten them more than necessary, as you may strip the threads, twist off the screw or place undue stress on the parts). Furthermore, always tighten by revolving in the direction of tightening tension.
- 4 The attachment screws must also be tightened sufficiently, upon completion of adjustments.
- 5 Always repeat checking operations after adjustments are made, in order to confirm results.

● Notes on the Tribrach

- 1 If any leveling screw becomes loose and slack or if collimation is unstable due to the looseness of leveling screws, adjust by tightening the adjusting screws (in 2 places) installed over each leveling screw with a screwdriver
- 2 If there is any slack between the leveling screws and the base, loosen the set screw of the holding ring and tighten the holding ring with adjusting pin, until it is properly adjusted. Re-tighten the set screw on completing the adjustment

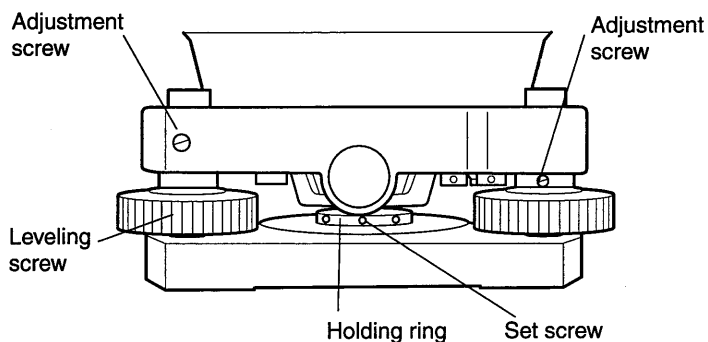

8.1 Checking /Adjusting the Plate Level

Adjustment is required if the axis of the plate level is not perpendicular to the vertical axis.

● Checking

- 1 Place the plate level parallel to a line running through the centers of two leveling screws, say, A and B. Use these two leveling screws only and place the bubble in the center of the plate level.
- 2 Rotate the instrument 180° or $200g$ around the vertical axis and check bubble movement of the plate level. If the bubble has been displaced, then proceed with the following adjustment.

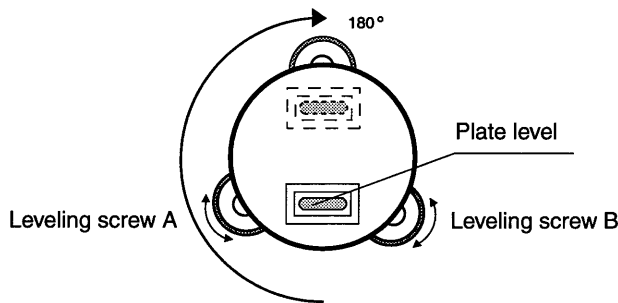

● Adjustment

- 1 Adjust the level adjustment capstan screw, with the accessory adjusting pin and return the bubble towards the center of the plate level. Correct only one-half of the displacement by this method.
- 2 Correct the remaining amount of the bubble displacement with the leveling screws.
- 3 Rotate the instrument 180° or $200g$ around the vertical axis once more and check bubble movement. If the bubble is still displaced, then repeat the adjustment.

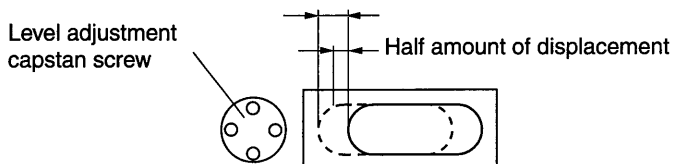

8.2 Checking and Adjusting the Circular Level

- **Checking**

- 1 Carefully level the instrument with the plate level only. If the bubble of the circular level is centered properly, adjustment is not required. Otherwise, proceed with the following adjustment.

- **Adjustment**

- 1 Shift the bubble to the center of the circular level, by adjusting three capstan adjustment screws on the bottom surface of the circular level, with the accessory adjusting pin.

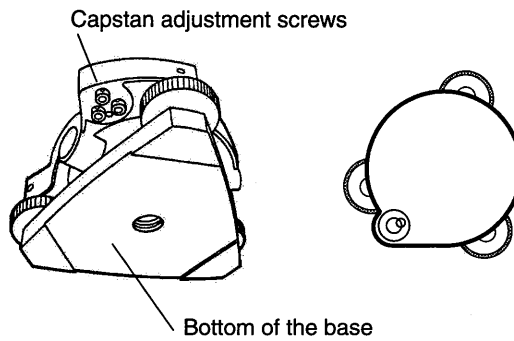

8.3 Adjustment of the Vertical Cross-hair

Adjustment is required if the vertical cross-hair is not in a plane perpendicular to the horizontal axis of the telescope (since it must be possible to use any point on the hair for measuring horizontal angles or running lines).

● Checking

- 1 Set the instrument up the tripod and carefully level it.
- 2 Sight the cross-hairs on a well defined Point A at a distance of, at least, 50 meters (160ft.) and clamp horizontal motion.
- 3 Next swing the telescope vertically using the vertical tangent screw, and check whether the point travels along the length of the vertical cross-hair.
- 4 If the point appears to move continuously on the hair, the vertical cross-hair lies in a plane perpendicular to the horizontal axis (and adjustment is not required).
- 5 However, if the point appears to be displaced from the vertical cross-hair, as the telescope is swung vertically, then proceed with the following adjustment.

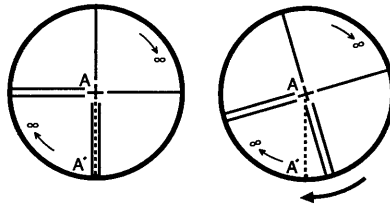

● Adjustment

- 1 Unscrew the cross-hair adjustment section cover, by revolving it in the counterclockwise direction, and take it off. This will expose four eyepiece section attachment screws.
- 2 Loosen all four attachment screws slightly with the accessory screw-drive (while taking note of the number of revolutions). Then revolve the eyepiece section so that the vertical cross-hair coincides to Point A'. Finally, re-tighten the four screws by the amount that they were loosened.

- 3** Check once more and if the point travels the entire length of the vertical cross-hair, further adjustment is not required.

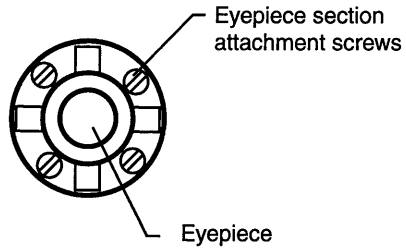

Perform following adjustment after completing the above adjustment .
Section 8.4 "Collimation of the Instrument", Section 8.6 "Adjustment of Vertical Angle 0 Datum".

8.4 Collimation of the Instrument

Collimation is required to make the line of sight of the telescope perpendicular to the horizontal axis of the instrument, otherwise, it will not be possible to extend a straight line by direct means.

● Checking

- 1 Set the instrument up with clear sights of about 50 to 60 meters (160 to 200 ft.) on both sides of the instrument.
- 2 Level the instrument properly with the plate level.
- 3 Sight Point A at approximately 50 meters (160 ft.) distance.
- 4 Loosen the vertical motion clamp only, and rotate the telescope 180° or 200g around the horizontal axis, so that the telescope is pointed in the opposite direction.
- 5 Sight Point B, at equal distance as Point A and tighten the vertical motion clamp.
- 6 Loosen the horizontal motion clamp and rotate the instrument 180° or 200g around the vertical axis. Fix a sight on Point A once more and tighten the horizontal motion clamp.
- 7 Loosen the vertical motion clamp only and rotate the telescope 180° or 200g around the horizontal axis once more and fix a sight on Point C, which should coincide with previous Point B.
- 8 If Points B and C do not coincide, adjust in the following manner.

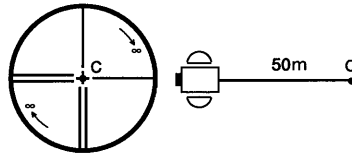
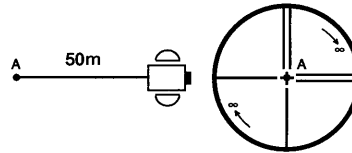
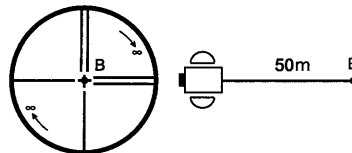
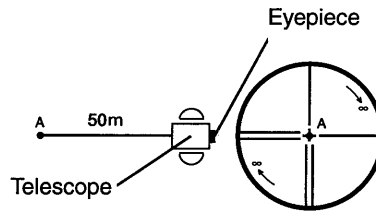

● **Adjustment**

1 Unscrew the cross-hair adjustment section cover.

2 Find Point D at a point between Points C and B, which should be equal to 1/4th the distance between Points B and C and measured from Point C. This is because the apparent error between Points B and C is four times the actual error since the telescope has been reversed twice during the checking operation.

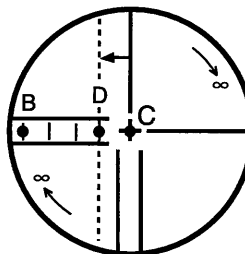

3 Shift the vertical cross-hair line and coincide it with Point D, by revolving the left and right capstan adjustment screws with the hexagonal wrench* (or adjusting pin). Upon completing the adjustment, repeat the checking operation once more.

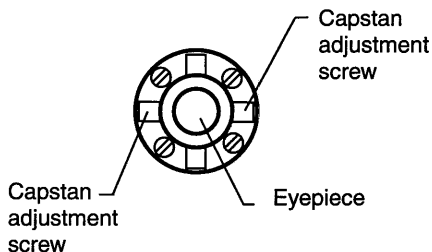

*DT-205/207/209/209P : Hexagonal wrench
DT-205L/207L/209L : Adjusting pin

If Points B and C coincide, further adjustment is not required. Otherwise, repeat the adjustment.



● First, loosen the capstan adjustment screw on the side to which the vertical cross-hair line must be moved. Then tighten the adjustment screw on the opposite side by an equal amount which will leave the tension of the adjustment screws unchanged.

Revolve in the counterclockwise direction to loosen and in the clockwise direction to tighten, but revolve as little as possible.

● Perform following adjustment after completing above adjustment . Section 8.6 "Adjustment of Vertical Angle 0 Datum".

8.5 Checking and Adjusting the Optical Plummet Telescope

Adjustment is required to make the line of sight of the optical plummet telescope coincide with the vertical axis (otherwise the vertical axis will not be in the true vertical when the instrument is optically plumbed).

● Checking

- 1 Coincide the center mark and the point. (See Chapter 2 "PREPARATION FOR MEASUREMENT" .)
- 2 Rotate the instrument 180° or 200g around the vertical axis and check the center mark.
If the point is properly centered in the center mark, adjustment is not required. Otherwise, adjust in the following manner.

● Adjustment

- 1 Take off the adjustment section cover of the optical plummet telescope eyepiece. This will expose four capstan adjustment screws which should be adjusted with the accessory adjusting pin to shift the center mark to the point. However, correct only one-half of the displacement in this manner.

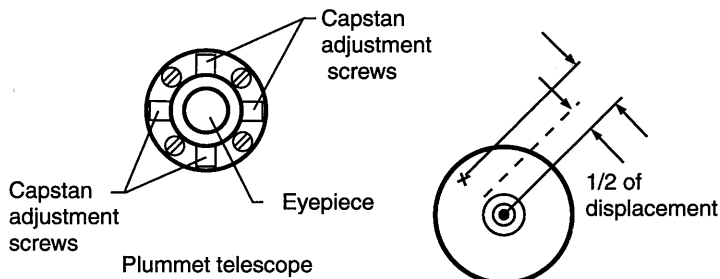

- 2 Use the leveling screws and coincide the point and center mark.
- 3 Rotate the instrument 180° or 200g around the vertical axis once more and check the center mark. If it is coincided to the point, then further adjustment is not required. Otherwise, repeat the adjustment.



First, loosen the capstan adjustment screw on the side to which the center mark must be moved. Then tighten the adjustment screw on the opposite side by an equal amount which will leave the tension of the adjustment screws unchanged. Revolve in the counterclockwise direction to loosen and in the clockwise direction to tighten, but revolve as little as possible.

8.6 Adjustment of Vertical Angle 0 Datum

If when measuring the vertical angle of target A at telescope position normal (direct) and reverse settings, the amount of normal and reverse measurements combined is other than 360° (ZENITH-0), half of the difference from 360° is the error amount from corrected 0 setting. Carry out adjustment. As adjustment for vertical angle 0 setting is the criteria for determining instrument coordinate origin, use special care for adjustment.

- 1 Level the instrument properly with the plate level.
- 2 While pressing the [OSET]key, turn power switch ON.

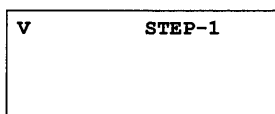

- 3 Collimate target A from the telescope properly in normal setting.
- 4 Press the [OSET] key.

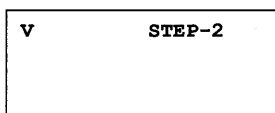

- 5 Collimate target A in reverse telescope setting.
- 6 Press the [OSET]key.
Measured value is set and carry out normal angle measurement.



- 7 Turn the power switch off.



- Any misoperating and error code display appears. Repeat the above procedure from the start.
- Check that the total amount of normal and reverse angular travel is 360° collimating the target A by normal and reverse positions.

8.7 Adjustment of Laser Beam

This adjustment must be done after completing following checking and adjusting. 8.3 "Adjustment of the Vertical Cross-hair", 8.4 "Collimation of the Instrument".

WARNING

- Aiming the instrument into prism or highly reflective surface can result in serious damage to your eye because the optical axis and laser beam source is in coincidence.
Do not aim the instrument directly into prism or highly reflective surface.
Do not look at the laser beam directly.

In intersection of the cross-hair does not coincide with the laser spot, turn the laser axis adjusting screws to move the laser spot to coincide with intersection of the cross-hair.

- 1 Remove the caps of the laser axis adjusting screws with coin.
As shown below, the screws are called A and B.

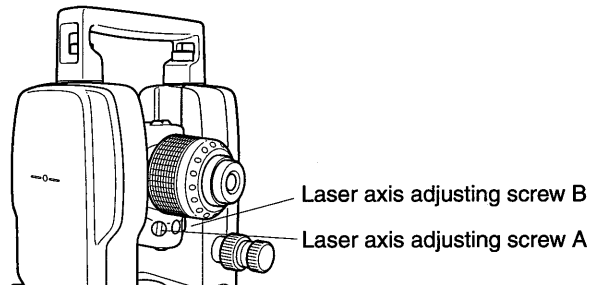

- 2 Following shows the moving direction of the laser spot by turning the laser adjusting screws.

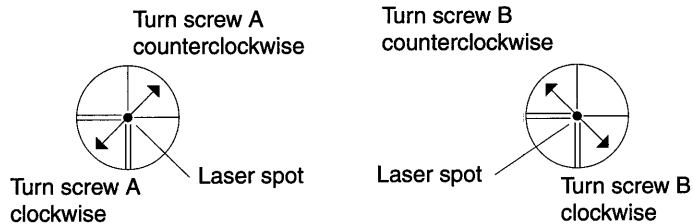

- 3 Attach the caps of the laser axis adjusting screws.

9 STORAGE PRECAUTIONS

- When returning the instrument to its case, be sure to match the white positioning marks provided with the case and place the instrument with the eyepiece upward.
- For cleaning the instrument after use, remove dust using a cleaning brush, then wipe off with a cloth.
- For cleaning the lens surface, use a cleaning brush to remove the dust, then use a clean lintless cotton cloth. Moisten it with alcohol (or mixture with ether) to wipe gently in a rotational motion from the center out.
- To remove the dust on the case, never use thinner or benzine. Use a clean cloth moistened with neutral detergent.
- Check each part of the tripod after extended use. Parts (screws or clamps) may work themselves free.

10 OPTIONAL ACCESSORIES

Diagonal Eyepiece, Model 13

The diagonal eyepiece is used in place of the telescope eyepiece for making observations up to the zenith.

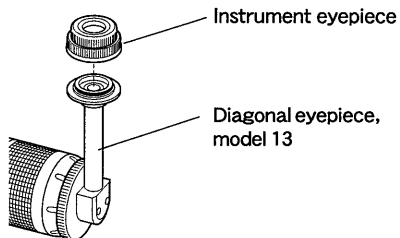

Trough Compass model 5

The trough compass is simply mounted on top of the carrying handle.

Back pack

When transporting the instrument with this back pack, it is very convenient for carrying the instrument on the shoulder. This soft case with aluminum frame is compact and light, yet, is highly shockproof and rainproof.

Aluminum extension leg tripod

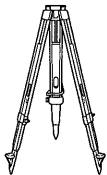

Wide frame extension leg tripod (wood)

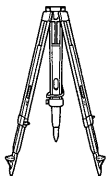

11 ERROR DISPLAY

Display	Contents	Countermeasure
AnGLE Error	Displayed when the instrument or the telescope rotated quickly.	In this case, it is not failure. However, repair is required when "AnGLE Error" is displayed frequently.
E04	Displayed when the discrepancy value of each measuring is more than $\pm 30''$ while repetition angle measurement is operated.	Press the [OSET] key, measure again from the beginning.
E70	When "Adjustment of Vertical Angle 0 datum" is adjusted in wrong procedure. or When "Adjustment of Vertical Angle 0 datum" is carried out to the range out of $\pm 45^\circ$ from the horizontal.	Switch off the power, then on again. Confirm the procedure and adjust again.
E99	Abnormality in internal memory system while "Adjustment of Vertical Angle 0 Datum" is operated, or horizontal angle is set zero or hold.	Switch off the power, then on again. Confirm the procedure and adjust again.

- If errors still persist after attempting to clear them, contact your dealer or TOPCON.

12 SPECIFICATIONS

(DT-205/207/209/209P)

Item	Item	Model		
		DT-205	DT-207	DT-209/ 209P
Telescope	Length	149mm	149mm	149mm
	Objective lens	45mm	45mm	40mm
	Magnification	30x	30x	26x
	Image	Erect	Erect	Erect
	Field of view	1° 30'	1° 30'	1° 30'
	Resolving power	2.5"	2.5"	3"
	Minimum focus	0.9m	0.9m	0.9m
	Stadia ratio	100	100	100
	Stadia constant	0	0	0
Electronic Angle Measurement	Method	Absolute	Absolute	Absolute
	Detecting	Horizontal : 2 sides	Horizontal : 2 sides	Horizontal : 1 sides
		Vertical : 1 side	Vertical : 1 side	Vertical : 1 side
	Minimum reading	1"/5" (0.5mgon/1mgon)	5"/10" (1mgon/2mgon)	10"/20" (2mgon/5mgon)
	Accuracy *1)	5"	7"	9"
	Diameter circle	71mm	71mm	71mm
Display	Unit	2 sides	2 sides	1 sides
Illumination	Display	Yes	Yes	Yes
	Reticle	Yes	Yes	No
Compensator	Tilt sensor	Automatic vertical compensator	No	No
	Compensating range	± 3'	No	No
Optical Plummet Telescope	Magnification	3x	3x	3x
	Filed of view	3°	3°	3°
	Focusing	0.5m~∞	0.5m~∞	0.5m~∞
Level Sensitivity	Plate level	40"/2 mm	40"/2 mm	60"/2 mm
	Circular level	10"/2mm	10"/2mm	10"/2mm
Water protection	Standard	IP 66	IP 66	IP 66
Power Supply	Battery	4 AA batteries	4 AA batteries	4 AA batteries
Operating Time (Alkaline manganese dry batteries), (+20°C (+68°F))	Theodolite only	Approx. 140 hours	Approx. 150 hours	Approx. 170 hours
Tribrach	Type	Detachable	Detachable	Fixing: DT-209 Centering: DT-209P

Item	Item	Model		
		DT-205	DT-207	DT-209/ 209P
Others	Dimension DxWxH(mm)	149x188x313 (5.87x7.1x12.3 in)	149x188x313 (5.87x7.1x12.3 in)	DT-209: 149x188x305 (5.87x7.1x12.0 in) DT-209P: 149x188x313 (5.87x7.1x12.3 in)
	Weight (Including batteries)	4.1 kg (9.0 lb)	4.1 kg (9.0 lb)	DT-209: 3.4kg (7.5 lb) DT-209P: 3.8kg (8.3 lb)
	Instrument height	176 mm (6.93 in)	176 mm (6.93 in)	-----
	Serial signal RS-232C connector	Yes	No	No

*1) Standard deviation based on DIN 18723
(DT-205L/207L/209L)

Item	Item	Model		
		DT-205L	DT-207L	DT-209L
Telescope	Length	152mm	152mm	152mm
	Objective lens	45mm	45mm	40mm
	Magnification	30x	30x	26x
	Image	Erect	Erect	Erect
	Field of view	1° 30'	1° 30'	1° 30'
	Resolving power	2.5"	2.5"	3"
	Minimum focus	1m	1m	1m
	Stadia ratio	100	100	100
	Stadia constant	0	0	0
Electronic Angle Measurement	Method	Absolute	Absolute	Absolute
	Detecting	Horizontal : 2 sides	Horizontal : 2 sides	Horizontal : 1 sides
		Vertical : 1 side	Vertical : 1 side	Vertical : 1 side
	Minimum reading	1"/5" (0.5mgon/1mgon)	5"/10" (1mgon/2mgon)	10"/20" (2mgon/5mgon)
	Accuracy *1)	5"	7"	9"
	Diameter circle	71mm	71mm	71mm
Display	Unit	2 sides	2 sides	1 sides
Illumination	Display	Yes	Yes	Yes
	Reticle	Yes	Yes	No
Compensator	Tilt sensor	Automatic vertical compensator	No	No
	Compensating range	±3'	No	No

Item	Item	Model		
		DT-205L	DT-207L	DT-209L
Optical Plummet Telescope	Magnification	3x	3x	3x
	Filed of view	3°	3°	3°
	Focusing	0.5m~∞	0.5m~∞	0.5m~∞
Level Sensitivity	Plate level	40"/2 mm	40"/2 mm	60"/2 mm
	Circular level	10"/2mm	10"/2mm	10"/2mm
Water protection	Standard	IP 66	IP 66	IP 66
Power Supply	Battery	4 AA batteries	4 AA batteries	4 AA batteries
Operating Time (Alkaline manganese dry batteries), (+20°C [+68°F])	Theodolite only	Approx. 140	Approx. 150	Approx. 170
	Laser only	Approx. 80	Approx. 80	Approx. 80
	Theodolite and laser	Approx. 45 (hours)	Approx. 45 (hours)	Approx. 45 (hours)
Tribrach	Type	Detachable	Detachable	Fixing
Others	Dimension DxWxH(mm)	152x188x313 (5.97x7.1x12.3 in)	152x188x313 (5.9x7.1x12.3 in)	152x188x305 (5.9x7.1x12.0 in)
	Weight (Including batteries)	4.2kg (9.2 lb)	4.2kg (9.2 lb)	3.6kg (7.9 lb)
	Instrument height	176 mm (6.93 in)	176 mm (6.93 in)	-----
	Serial signal RS-232C connector	Yes	No	No
Laser beam	Laser class	Class 2 Class II	Class 2 Class II	Class 2 Class II
	Wave length	633nm	633nm	633nm
	Maximum output	0.6mW	0.6mW	0.6mW
	Laser beam range*2)	50m	50m	50m

*1) Standard deviation based on DIN 18723

Laser beam

Laser class : Class II (Class 2)
Wave length : 633nm
Maximum output : 0.6mW
Laser beam range : 50m
Condition Weather : Fine
Time : The daylight hours

Laser beam diameter(When focused) *2)

Telescope Magnification	Distance(m)	5	10	20	30	50
30x	Beam diameter(m)	0.1x0.2	0.2x0.4	0.5x0.7	0.7x1.1	1.2x1.9
26x	Beam diameter(m)	0.1x0.2	0.3x0.4	0.6x0.8	0.8x1.2	1.4x2.0

*2) The laser beam diameters are theoretical values
The visible laser beam diameter will vary with brightness of circumstance.

TOPCON POSITIONING SYSTEMS, INC.

7400 National Drive, Livermore, CA 94551, U.S.A.
Phone: 925-245-8300 Fax: 925-245-8599 www.topcon.com

TOPCON CALIFORNIA

3380 Industrial Blvd, Suite 105, West Sacramento, CA 95691, U.S.A.
Phone: 916-374-8575 Fax: 916-374-8329

TOPCON EUROPE POSITIONING B.V.

Esebaan 11, 2908 LJ Capelle a/d IJssel, The Netherlands.
Phone: 010-458-5077 Fax: 010-284-4949 www.topconeuropa.com

IRELAND OFFICE

Unit 68 Western Parkway Business Center
Lower Ballymount Road, Dublin 12, Ireland
Phone: 01469-0021 Fax: 01469-0129

TOPCON DEUTSCHLAND G.m.b.H.

Gieselerallee 31, 47877 Willich, GERMANY
Phone: 02154-885-100 Fax: 02154-885-111 info@topcon.de
www.topcon.de

TOPCON S.A.R.L.

89, Rue de Paris, 92585 Clichy, Cedex, France.
Phone: 33-1-41069490 Fax: 33-1-47390251 topcon@topcon.fr

TOPCON ESPAÑA S.A.

Frederic Mompuou 5, Ed. Euro 3, 08960, Sant Just Desvern, Barcelona, Spain.
Phone: 93-473-4057 Fax: 93-473-3932 www.topconesp.com

TOPCON SCANDINAVIA A. B.

Neongatan 2 S-43151 Mölndal, SWEDEN
Phone: 031-7109200 Fax: 031-7109249

TOPCON (GREAT BRITAIN) LTD.

Topcon House Kennet Side, Bone Lane, Newbury, Berkshire RG14 5PX U.K.
Phone: 44-1635-551120 Fax: 44-1635-551170
survey.sales@topcon.co.uk laser.sales@topcon.co.uk

TOPCON SOUTH ASIA PTE. LTD.

Bk1 192 Pandan Loop, #07-01 Pantech Industrial Complex, Singapore 128381
Phone: 62780222 Fax: 62733540 www.topcon.com.sg

TOPCON AUSTRALIA PTY. LTD.

Unit 18, 4 Avenue of Americas Newington NSW 2127, Australia
Phone: 02-8748-8777 Fax: 02-9647-2926 www.topcon.com.au

TOPCON INSTRUMENTS (THAILAND) CO., LTD.

77/162 Sinn Sathom Tower, 37th Fl.,
Klongthongburi Rd., Klongthongsa, Klongsam, Bangkok 10600 Thailand.
Phone: 02-440-1152-7 Fax: 02-440-1158

TOPCON INSTRUMENTS (MALAYSIA) SDN. BHD.

Excella Business Park Block C, Ground & 1st Floor, Jalan Ampang Putra,
Taman Ampang Hill, 55100 Kuala Lumpur, MALAYSIA
Phone: 03-42701068 Fax: 03-42704508

TOPCON KOREA CORPORATION

2F Yoseong Bldg., 1595-3, Seocho-Dong, Seocho-gu, Seoul, 137-676, Korea.
Phone: 82-2-2055-0321 Fax: 82-2-2055-0319 www.topcon.co.kr

TOPCON OPTICAL (H.K.) LIMITED

2-4F Meeco Industrial Bldg., No. 53-55 Au Pui Wan Street, Fo Tan Road,
Sha Tin, N.T., Hong Kong
Phone: 2990-1328 Fax: 2990-2221 www.topcon.com.hk

TOPCON CORPORATION BEIJING OFFICE

Building A No.9, Kangding Street
Beijing Economic Technological Development Area, Beijing, China 100176
Phone: 10-6780-2789 Fax: 10-6780-2790

TOPCON CORPORATION BEIRUT OFFICE

P. O. BOX 70-1002 Antelias, BEIRUT-LEBANON
Phone: 961-4-523525/961-4-523526 Fax: 961-4-521119

TOPCON CORPORATION DUBAI OFFICE

C/O Atlas Medical FZCO., P. O. Box 54304, C-25, Dubai Airport Free Zone, UAE
Phone: 971-4-2995900 Fax: 971-4-2995901

TOPCON CORPORATION

75-1 Hasunuma-cho, Itabashi-ku, Tokyo 174-8580, Japan
Phone: 3-3558-2520 Fax: 3-3960-4214 www.topcon.co.jp